

**How to Order**

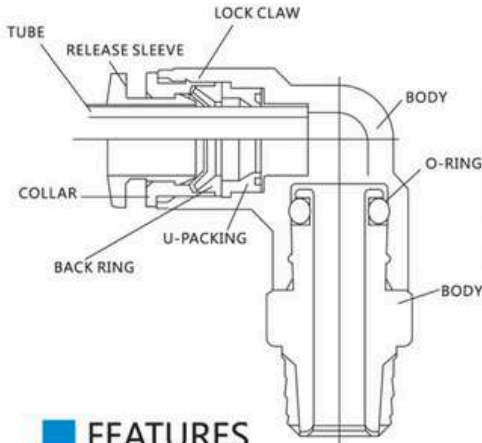

**SPECIFICATIONS**

Fluid type	Air , Vacuum
Operating pressure	0-10.2kgf/cm ( 0-1.0mpg )
Negative pressure	-750mmHg ( 10Torr )
Operating Temperature range	0-60°C
Tube material	Nylon and Polyurethane

**FEATURES**

One-Touch Push-to-connect configuration allows an instant tubing connection.

Smooth-Edge release sleeve design facilitates a quick tubing disconnection

Aesthetically pleasing nickel-plated metallic optional feature ensures anti-corrosion and anti-contamination properties of an extended product life.

Pre-applied sealant on all external threads eliminates the additional sealing requirement.

Internal and/of external flat-to-flat hexagonal configurations for both metric and inch specifications allow a proper tightening allen wrench for the applicable model types.

**PRODUCT CODE DESIGNATION**

PC	08	02
①	②	③

① **MODEL TYPE**

② **TUBE OUTER DIAMETER ( ΦD )**

	Metric Tube						Inch Tube				
Code	04	06	08	10	12	14	16	1/4	5/16	3/8	1/2
ΦD	4mm	6mm	8mm	10mm	12mm	14mm	16mm	1/4	5/16	3/8	1/2

③ **THREAD TYPE&SIZE  
METRIC SIZE**

Metric Tube			
Code	M5	M6	M8
Size	M5X0.8	M6X1	M8X1

**TAPER PIPE THREAD**

R(PT)Thread				
Code	01	02	03	04
Size	R1/8	R1/4	R3/8	R1/2

G(PF)Thread				
Code	G01	G02	G03	G04
Size	G1/8	G1/4	G3/8	G1/2

NPT Thread				
Code	N1	N2	N3	N4
Size	NPT1/8	NPT1/4	NPT3/8	NPT1/2

**Optional Color**

Blue White Black





**How to Order**

PC  ΦD  T	MODEL [ΦD-T]							
	Tube(Metric)-Thread(R)			Tube(Inch)-Thread(R)		Tube(Inch)-Thread(NPT)		
	PC 04-M5	PC 06-04	PC 12-02	PC 1/4-01	PC 3/8-04	PC 5/32-U	PC 1/4-N2	PC 1/2-N2
	PC 04-M6	PC 08-01	PC 12-03	PC 1/4-02	PC 1/2-02	PC 5/32-N1	PC 1/4-N3	PC 1/2-N3
	PC 04-01	PC 08-02	PC 12-04	PC 1/4-03	PC 1/2-03	PC 5/32-N2	PC 5/16-N1	PC 1/2-N4
	PC 04-02	PC 08-03	PC 14-03	PC 5/16-01	PC 1/2-04	PC 3/16-U	PC 5/16-N2	
	PC 06-M5	PC 08-04	PC 14-04	PC 5/16-02		PC 3/16-N1	PC 5/16-N3	
	PC 06-M6	PC 10-01	PC 16-03	PC 5/16-03		PC 3/16-N2	PC 3/8-N1	
	PC 06-01	PC 10-02	PC 16-04	PC 3/8-01		PC 3/16-N3	PC 3/8-N2	
	PC 06-02	PC 10-03		PC 3/8-02		PC 1/4-U	PC 3/8-N3	
	PC 06-03	PC 10-04		PC 3/8-03		PC 1/4-N1	PC 3/8-N4	

PCF  ΦD  T	MODEL [ΦD-T]				
	Tube(Metric)-Thread(Rc)		Tube(Inch)-Thread(Rc)		Tube(Inch)-Thread(NPT)
	PCF 04-01	PCF 10-01	PCF 1/4-01	PCF 5/32-N1	
	PCF 04-02	PCF 10-02	PCF 1/4-02	PCF 5/32-N2	PCF 3/8-N2
	PCF 06-01	PCF 10-03	PCF 5/16-01	PCF 3/16-N1	PCF 3/8-N3
	PCF 06-02	PCF 10-04	PCF 5/16-02	PCF 3/16-N2	PCF 1/2-N2
	PCF 06-03	PCF 12-02	PCF 3/8-02	PCF 1/4-N1	PCF 1/2-N3
	PCF 08-01	PCF 12-03	PCF 3/8-03	PCF 1/4-N2	
	PCF 08-02	PCF 12-04		PCF 5/16-N1	
	PCF 08-03	PCF 16-03		PCF 5/16-N2	
	PCF 08-04	PCF 16-04		PCF 5/16-N3	

POC  ΦD  T	MODEL [ΦD-T]					
	Tube(Metric)-Thread(R)			Tube(Inch)-Thread(R)		Tube(Inch)-Thread(NPT)
	POC 04-M5	POC 08-01	POC 12-03	POC 1/4-01	POC 5/32-U	POC 3/8-N3
	POC 04-M6	POC 08-02	POC 12-04	POC 1/4-02	POC 5/32-N1	POC 3/8-N4
	POC 04-01	POC 08-03	POC 14-03	POC 5/16-01	POC 1/4-U	POC 1/2-N2
	POC 04-02	POC 08-04	POC 14-04	POC 5/16-02	POC 1/4-N1	POC 1/2-N3
	POC 06-M5	POC 10-01	POC 16-03	POC 5/16-03	POC 1/4-N2	POC 1/2-N4
	POC 06-M6	POC 10-02	POC 16-04	POC 3/8-02	POC 5/16-N1	
	POC 06-01	POC 10-03		POC 3/8-03	POC 5/16-N2	
	POC 06-02	POC 10-04		POC 3/8-04	POC 5/16-N3	
	POC 06-03	POC 12-02			POC 3/8-N2	

PM  ΦD  T	MODEL [ΦD]	
	Tube(Metric)	Tube(Inch)
	PM 04	PM 5/32
	PM 06	PM 3/16
	PM 08	PM 1/4
	PM 10	PM 5/16
	PM 12	PM 3/8
	PM 14	PM 1/2
	PM 16	

PMF  ΦD  T	MODEL [ΦD-T]			
	Tube(Metric)-Thread(Rc)		Tube(Inch)-Thread(NPT)	
	PMF 04-01	PMF 10-01	PMF 5/32-N1	PMF 5/16-N3
	PMF 04-02	PMF 10-02	PMF 3/16-N1	PMF 1/2-N3
	PMF 06-01	PMF 10-03	PMF 3/16-N2	PMF 1/2-N4
	PMF 06-02	PMF 10-04	PMF 1/4-N1	
	PMF 06-03	PMF 12-02	PMF 1/4-N2	
	PMF 08-01	PMF 12-03	PMF 5/16-N1	
	PMF 08-02	PMF 12-04	PMF 5/16-N2	
	PMF 08-03	PMF 14-04	PMF 5/16-N3	
	PMF 08-04	PMF 16-04	PMF 3/8-N2	

**Push in fitting  
 Plastic type**

**How to Order**

	MODEL [ΦD-T]							
	Tube(Metric)-Thread(R)			Tube(Inch)-Thread(R)		Tube(Inch)-Thread(NPT)		
	PL 04-M5	PL 06-04	PL 12-02	PL 1/4-01	PL 3/8-04	PL 5/32-U	PL 1/4-N2	PL 1/2-N2
PL 04-M6	PL 08-01	PL 12-03	PL 1/4-02	PL 1/2-02	PL 5/32-N1	PL 1/4-N3	PL 1/2-N3	
PL 04-01	PL 08-02	PL 12-04	PL 1/4-03	PL 1/2-03	PL 5/32-N2	PL 5/16-N1	PL 1/2-N4	
PL 04-02	PL 08-03	PL 14-03	PL 5/16-01	PL 1/2-04	PL 3/16-U	PL 5/16-N2		
PL 06-M5	PL 08-04	PL 14-04	PL 5/16-02		PL 3/16-N1	PL 5/16-N3		
PL 06-M6	PL 10-01	PL 16-03	PL 5/16-03		PL 3/16-N2	PL 3/8-N1		
PL 06-01	PL 10-02	PL 16-04	PL 3/8-01		PL 3/16-N3	PL 3/8-N2		
PL 06-02	PL 10-03		PL 3/8-02		PL 1/4-U	PL 3/8-N3		
PL 06-03	PL 10-04		PL 3/8-03		PL 1/4-N1	PL 3/8-N4		

	MODEL [ΦD-T]					
	Tube(Metric)-Thread(Rc)			Tube(Inch)-Thread(NPT)		
	PLF 04-M5	PLF 08-01	PLF 12-03	PLF 5/32-N1		
PLF 04-M6	PLF 08-02	PLF 12-04	PLF 3/16-N1			
PLF 04-01	PLF 08-03	PLF 14-03	PLF 3/16-N2	PLF 3/8-N3		
PLF 04-02	PLF 08-04	PLF 14-04	PLF 1/4-N1	PLF 1/2-N2		
PLF 06-M5	PLF 10-01	PLF 16-03	PLF 1/4-N2	PLF 1/2-N3		
PLF 06-M6	PLF 10-02	PLF 16-04	PLF 5/16-N1			
PLF 06-01	PLF 10-03		PLF 5/16-N2			
PLF 06-02	PLF 10-04		PLF 5/16-N3			
PLF 06-03	PLF 12-02		PLF 3/8-N2			

	MODEL [ΦD-T]						
	Tube(Metric)-Thread(R)			Tube(Inch)-Thread(R)		Tube(Inch)-Thread(NPT)	
	PLL 04-M5	PLL 06-04	PLL 12-02	PLL 1/4-01	PLL 5/32-U	PLL 5/16-N2	
PLL 04-M6	PLL 08-01	PLL 12-03	PLL 1/4-02	PLL 5/32-N1	PLL 5/16-N3		
PLL 04-01	PLL 08-02	PLL 12-04	PLL 5/16-02	PLL 3/16-N1	PLL 3/8-N2		
PLL 04-02	PLL 08-03	PLL 14-03	PLL 3/8-02	PLL 3/16-N2	PLL 3/8-N3		
PLL 06-M5	PLL 08-04	PLL 14-04	PLL 3/8-03	PLL 3/16-N3	PLL 3/8-N4		
PLL 06-M6	PLL 10-01	PLL 16-03		PLL 1/4-N1	PLL 1/2-N2		
PLL 06-01	PLL 10-02	PLL 16-04		PLL 1/4-N2	PLL 1/2-N3		
PLL 06-02	PLL 10-03			PLL 1/4-N3	PLL 1/2-N4		
PLL 06-03	PLL 10-04			PLL 5/16-N1			

	MODEL [ΦD-T]						
	Tube(Metric)-Thread(R)			Tube(Inch)-Thread(R)		Tube(Inch)-Thread(NPT)	
	PB 04-M5	PB 06-04	PB 12-02	PB 1/4-01	PB 3/8-04	PB 5/32-U	PB 1/4-N2
PB 04-M6	PB 08-01	PB 12-03	PB 1/4-02	PB 1/2-02	PB 5/32-N1	PB 1/4-N3	PB 1/2-N3
PB 04-01	PB 08-02	PB 12-04	PB 1/4-03	PB 1/2-03	PB 5/32-N2	PB 5/16-N1	PB 1/2-N4
PB 04-02	PB 08-03	PB 14-03	PB 5/16-01	PB 1/2-04	PB 3/16-U	PB 5/16-N2	
PB 06-M5	PB 08-04	PB 14-04	PB 5/16-02		PB 3/16-N1	PB 5/16-N3	
PB 06-M6	PB 10-01	PB 16-03	PB 5/16-03		PB 3/16-N2	PB 3/8-N1	
PB 06-01	PB 10-02	PB 16-04	PB 3/8-01		PB 3/16-N3	PB 3/8-N2	
PB 06-02	PB 10-03		PB 3/8-02		PB 1/4-U	PB 3/8-N3	
PB 06-03	PB 10-04		PB 3/8-03		PB 1/4-N1	PB 3/8-N4	

	MODEL [ΦD-T]							
	Tube(Metric)-Thread(R)			Tube(Inch)-Thread(R)		Tube(Inch)-Thread(NPT)		
	PBF 04-M5	PBF 06-04	PBF 12-02	PBF 1/4-01	PBF 3/8-04	PBF 5/32-U	PBF 1/4-N2	PBF 1/2-N2
PBF 04-M6	PBF 08-01	PBF 12-03	PBF 1/4-02	PBF 1/2-02	PBF 5/32-N1	PBF 1/4-N3	PBF 1/2-N3	
PBF 04-01	PBF 08-02	PBF 12-04	PBF 1/4-03	PBF 1/2-03	PBF 5/32-N2	PBF 5/16-N1	PBF 1/2-N4	
PBF 04-02	PBF 08-03	PBF 14-03	PBF 5/16-01	PBF 1/2-04	PBF 3/16-U	PBF 5/16-N2		
PBF 06-M5	PBF 08-04	PBF 14-04	PBF 5/16-02		PBF 3/16-N1	PBF 5/16-N3		
PBF 06-M6	PBF 10-01	PBF 16-03	PBF 5/16-03		PBF 3/16-N2	PBF 3/8-N1		
PBF 06-01	PBF 10-02	PBF 16-04	PBF 3/8-01		PBF 3/16-N3	PBF 3/8-N2		
PBF 06-02	PBF 10-03		PBF 3/8-02		PBF 1/4-U	PBF 3/8-N3		
PBF 06-03	PBF 10-04		PBF 3/8-03		PBF 1/4-N1	PBF 3/8-N4		

**Push in fitting  
 Plastic type**

**How to Order**

PD	MODEL [ΦD-T]							
	Tube(Metric)-Thread(R)			Tube(Inch)-Thread(R)		Tube(Inch)-Thread(NPT)		
	PD 04-M5	PD 06-04	PD 12-02	PD 1/4-01	PD 3/8-04	PD 5/32-U	PD 1/4-N2	PD 1/2-N2
	PD 04-M6	PD 08-01	PD 12-03	PD 1/4-02	PD 1/2-02	PD 5/32-N1	PD 1/4-N3	PD 1/2-N3
	PD 04-01	PD 08-02	PD 12-04	PD 1/4-03	PD 1/2-03	PD 5/32-N2	PD 5/16-N1	PD 1/2-N4
	PD 04-02	PD 08-03	PD 14-03	PD 5/16-01	PD 1/2-04	PD 3/16-U	PD 5/16-N2	
	PD 06-M5	PD 08-04	PD 14-04	PD 5/16-02		PD 3/16-N1	PD 5/16-N3	
	PD 06-M6	PD 10-01	PD 16-03	PD 5/16-03		PD 3/16-N2	PD 3/8-N1	
	PD 06-01	PD 10-02	PD 16-04	PD 3/8-01		PD 3/16-N3	PD 3/8-N2	
	PD 06-02	PD 10-03		PD 3/8-02		PD 1/4-U	PD 3/8-N3	
	PD 06-03	PD 10-04		PD 3/8-03		PD 1/4-N1	PD 3/8-N4	

PX	MODEL [ΦD-T]							
	Tube(Metric)-Thread(R)			Tube(Inch)-Thread(R)		Tube(Inch)-Thread(NPT)		
	PX 04-M5	PX 06-04	PX 12-02	PX 1/4-01	PX 3/8-04	PX 5/32-U	PX 1/4-N2	PX 1/2-N2
	PX 04-M6	PX 08-01	PX 12-03	PX 1/4-02	PX 1/2-02	PX 5/32-N1	PX 1/4-N3	PX 1/2-N3
	PX 04-01	PX 08-02	PX 12-04	PX 1/4-03	PX 1/2-03	PX 5/32-N2	PX 5/16-N1	PX 1/2-N4
	PX 04-02	PX 08-03		PX 5/16-01	PX 1/2-04	PX 3/16-U	PX 5/16-N2	
	PX 06-M5	PX 08-04		PX 5/16-02		PX 3/16-N1	PX 5/16-N3	
	PX 06-M6	PX 10-01		PX 5/16-03		PX 3/16-N2	PX 3/8-N1	
	PX 06-01	PX 10-02		PX 3/8-01		PX 3/16-N3	PX 3/8-N2	
	PX 06-02	PX 10-03		PX 3/8-02		PX 1/4-U	PX 3/8-N3	
	PX 06-03	PX 10-04		PX 3/8-03		PX 1/4-N1	PX 3/8-N4	

PH	MODEL [ΦD-T]					
	Tube(Metric)-Thread(R)			Tube(Inch)-Thread(R)		Tube(Inch)-Thread(NPT)
	PH 04-M5	PH 08-01	PH 12-04	PH 1/4-M5	PH 5/32-U	PH 5/16-N3
	PH 04-M6	PH 08-02		PH 1/4-01	PH 5/32-N1	PH 3/8-N2
	PH 04-01	PH 08-03		PH 1/4-02	PH 3/16-U	PH 3/8-N3
	PH 04-02	PH 08-04		PH 5/16-01	PH 3/16-N1	PH 1/2-N3
	PH 06-M5	PH 10-02		PH 5/16-02	PH 3/16-N2	PH 1/2-N4
	PH 06-M6	PH 10-03		PH 5/16-03	PH 1/4-N1	
	PH 06-01	PH 10-04		PH 3/8-02	PH 1/4-N2	
	PH 06-02	PH 12-02		PH 3/8-03	PH 5/16-N1	
	PH 06-03	PH 12-03			PH 5/16-N2	

PHF	MODEL [ΦD-T]					
	Tube(Metric)-Thread(R)			Tube(Inch)-Thread(R)		Tube(Inch)-Thread(NPT)
	PHF 04-M5	PHF 08-01	PHF 12-04	PHF 1/4-M5	PHF 5/32-U	PHF 5/16-N3
	PHF 04-M6	PHF 08-02		PHF 1/4-01	PHF 5/32-N1	PHF 3/8-N2
	PHF 04-01	PHF 08-03		PHF 1/4-02	PHF 3/16-U	PHF 3/8-N3
	PHF 04-02	PHF 08-04		PHF 5/16-01	PHF 3/16-N1	PHF 1/2-N3
	PHF 06-M5	PHF 10-02		PHF 5/16-02	PHF 3/16-N2	PHF 1/2-N4
	PHF 06-M6	PHF 10-03		PHF 5/16-03	PHF 1/4-N1	
	PHF 06-01	PHF 10-04		PHF 3/8-02	PHF 1/4-N2	
	PHF 06-02	PHF 12-02		PHF 3/8-03	PHF 5/16-N1	
	PHF 06-03	PHF 12-03			PHF 5/16-N2	

  

PGJ	MODEL [ΦD1-ΦD2]		
	Tube(Metric)	Tube(Metric)-Tube(Inch)	Tube(Inch)-Thread(NPT)
	PGJ 06-04	PGJ 08-1/4	PGJ 1/4-5/32
	PGJ 08-04	PGJ 10-1/4	PGJ 5/16-5/32
	PGJ 08-06	PGJ 10-5/16	PGJ 5/16-1/4
	PGJ 10-06	PGJ 12-1/4	PGJ 3/8-1/4
	PGJ 10-08	PGJ 12-5/16	PGJ 3/8-5/16
	PGJ 12-06		PGJ 1/2-1/4
	PGJ 12-08		PGJ 1/2-5/16
	PGJ 12-10		PGJ 1/2-3/8

**Push in fitting  
 Plastic type**

**How to Order**

	MODEL [ΦD]	
	Tube(Metric)	Tube(Inch)
	PU 04	PU 5/32
	PU 06	PU 3/16
	PU 08	PU 1/4
	PU 10	PU 5/16
	PU 12	PU 3/8
	PU 14	PU 1/2
	PU 16	

	MODEL [ΦD]	
	Tube(Metric)	Tube(Inch)
	PV 04	PV 5/32
	PV 06	PV 3/16
	PV 08	PV 1/4
	PV 10	PV 5/16
	PV 12	PV 3/8
	PV 14	PV 1/2
	PV 16	

	MODEL [ΦD]	
	Tube(Metric)	Tube(Inch)
	PE 04	PE 5/32
	PE 06	PE 3/16
	PE 08	PE 1/4
	PE 10	PE 5/16
	PE 12	PE 3/8
	PE 14	PE 1/2
	PE 16	

	MODEL [ΦD]	
	Tube(Metric)	Tube(Inch)
	PY 04	PY 5/32
	PY 06	PY 3/16
	PY 08	PY 1/4
	PY 10	PY 5/16
	PY 12	PY 3/8
		PY 1/2

	MODEL [ΦD1-ΦD2]	
	Tube(Metric)	Tube(Inch)
	PW 06-04	PW 3/16-5/32
	PW 08-06	PW 1/4-5/32
	PW 10-08	PW 1/4-3/16
	PW 12-10	PW 5/16-1/4
		PW 3/8-5/16
		PW 1/2-3/8

	MODEL [ΦD1-ΦD2]	
	Tube(Metric)	Tube(Inch)
	PG 06-04	PG 3/16-5/32
	PG 08-04	PG 1/4-5/32
	PG 08-06	PG 1/4-3/16
	PG 10-06	PG 5/16-1/4
	PG 10-08	PG 3/8-5/16
	PG 12-10	PG 1/2-3/8
	PG 16-12	
	PG 16-14	

	MODEL [ΦD1-ΦD2]	
	Tube(Metric)	Tube(Inch)
	PEG 06-04	PEG 1/4-5/32
	PEG 08-06	PEG 5/16-1/4
	PEG 10-08	PEG 3/8-5/16
	PEG 12-10	PEG 1/2-3/8
	PEG 16-12	

	MODEL [ΦD]	
	Tube(Metric)	Tube(Inch)
	PLJ 04	PLJ 5/32
	PLJ 06	PLJ 3/16
	PLJ 08	PLJ 1/4
	PLJ 10	PLJ 5/16
	PLJ 12	PLJ 3/8
		PLJ 1/2

	MODEL [ΦD1-ΦD2]	
	Tube(Metric)	Tube(Inch)
	PWJ 06-04	PWJ 1/4-5/32
	PWJ 08-06	PWJ 5/16-1/4
	PWJ 10-08	PWJ 3/8-5/16
	PWJ 12-10	PWJ 1/2-3/8

	MODEL [ΦD]	
	Tube(Metric)	Tube(Inch)
	PYJ 04	PYJ 5/32
	PYJ 06	PYJ 3/16
	PYJ 08	PYJ 1/4
	PYJ 10	PYJ 5/16
	PYJ 12	PYJ 3/8
		PYJ 1/2

**Push in fitting  
 Plastic type**

**How to Order**

PSJ	MODEL [ΦD1-ΦD2]	
	Tube(Metric)	Tube(Inch)
 <p>ΦD1</p> <p>ΦD2</p>	PSJ 06-04	PSJ 1/4-5/32
	PSJ 08-06	PSJ 5/16-1/4
	PSJ 10-08	PSJ 3/8-5/16
	PSJ 12-10	PSJ 1/2-3/8

PTJ	MODEL [ΦD]	
	Tube(Metric)	Tube(Inch)
 <p>ΦD2</p> <p>ΦD1</p>	PTJ 06-04	PTJ 1/4-5/32
	PTJ 08-06	PTJ 5/16-1/4
	PTJ 10-08	PTJ 3/8-5/16
	PTJ 12-10	PTJ 1/2-3/8

PU	MODEL [ΦD]	
	Tube(Metric)	Tube(Inch)
 <p>ΦD</p>	PU 04	PU 5/32
	PU 06	PU 3/16
	PU 08	PU 1/4
	PU 10	PU 5/16
	PU 12	PU 3/8
	PU 16	PU 1/2

PP	MODEL [ΦD]	
	Tube(Metric)	Tube(Inch)
 <p>ΦD</p>	PP 04	PP 5/32
	PP 06	PP 3/16
	PP 08	PP 1/4
	PP 10	PP 5/16
	PP 12	PP 3/8
	PP 16	PP 1/2

PKG	MODEL [ΦD1-ΦD2]	
	Tube(Metric)	Tube(Inch)
 <p>ΦD2</p> <p>ΦD1</p>	PKG 06-04	PKG 3/16-5/32
	PKG 08-04	PKG 1/4-5/32
	PKG 08-06	PKG 5/16-5/32
	PKG 10-06	PKG 3/16-3/16
	PKG 10-08	PKG 5/16-1/4
		PKG 3/8-1/4

PIG	MODEL [ΦD1-ΦD2]	
	Tube(Metric)	Tube(Inch)
 <p>ΦD2</p> <p>ΦD1</p>	PIG 06-04	PIG 3/16-5/32
	PIG 08-06	PIG 1/4-5/32
	PIG 10-08	PIG 1/4-3/16
	PIG 12-10	PIG 5/16-1/4
	PIG 16-12	PIG 3/8-5/16
		PIG 1/2-3/8

PKD	MODEL [ΦD1-ΦD2-T]	
	Tube(Metric)	Tube(Inch)
 <p>T</p> <p>ΦD2</p> <p>ΦD1</p>	PKD 06-04-01	PKD 3/16-5/32-N1
	PKD 08-04-02	PKD 1/4-5/32-N1
	PKD 08-06-02	PKD 5/16-5/32-N2
	PKD 10-08-03	PKD 5/16-1/4-N2
		PKD 3/8-5/16-N3

PZA	MODEL [ΦD]	
	Tube(Metric)	Tube(Inch)
 <p>ΦD</p>	PZA 04	PZA 5/32
	PZA 06	PZA 3/16
	PZA 08	PZA 1/4
	PZA 10	PZA 5/16
	PZA 12	PZA 3/8
		PZA 1/2

PKB	MODEL [ΦD1-ΦD2-T]	
	Tube(Metric)	Tube(Inch)
 <p>T</p> <p>ΦD</p>	PKB 04-01	
	PKB 04-02	
	PKB 06-01	
	PKB 06-02	
	PKB 06-03	
	PKB 08-01	
	PKB 08-02	
	PKB 08-03	

PK	MODEL [ΦD]	
	Tube(Metric)	Tube(Inch)
 <p>ΦD</p>	PK 04	PK 5/32
	PK 06	PK 3/16
	PK 08	PK 1/4
		PK 5/16

**Push in fitting  
 Plastic type**

**How to Order**

PC-G	MODEL [ΦD-T]		
	Tube(Metric)-Thread(G)		
	PC 04-G01	PC 08-G04	PC 14-G04
	PC 04-G02	PC 10-G01	PC 16-G03
	PC 06-G01	PC 10-G02	PC 16-G04
	PC 06-G02	PC 10-G03	
	PC 06-G03	PC 10-G04	
	PC 06-G04	PC 12-G02	
	PC 08-G01	PC 12-G03	
	PC 08-G02	PC 12-G04	
	PC 08-G03	PC 14-G03	

PL-G	MODEL [ΦD-T]		
	Tube(Metric)-Thread(G)		
	PL 04-G01	PL 08-G04	PL 14-G04
	PL 04-G02	PL 10-G01	PL 16-G03
	PL 06-G01	PL 10-G02	PL 16-G04
	PL 06-G02	PL 10-G03	
	PL 06-G03	PL 10-G04	
	PL 06-G04	PL 12-G02	
	PL 08-G01	PL 12-G03	
	PL 08-G02	PL 12-G04	
	PL 08-G03	PL 14-G03	

PCF-G	MODEL [ΦD-T]		
	Tube(Metric)-Thread(G)		
	PCF 04-G01	PCF 10-G01	PCF 16-G03
	PCF 04-G02	PCF 10-G02	PCF 16-G04
	PCF 06-G01	PCF 10-G03	
	PCF 06-G02	PCF 10-G04	
	PCF 06-G03	PCF 12-G02	
	PCF 08-G01	PCF 12-G03	
	PCF 08-G02	PCF 12-G04	
	PCF 08-G03	PCF 14-G03	
	PCF 08-G04	PCF 14-G04	

PLF-G	MODEL [ΦD-T]		
	Tube(Metric)-Thread(G)		
	PLF 04-G01	PLF 10-G01	PLF 16-G03
	PLF 04-G02	PLF 10-G02	PLF 16-G04
	PLF 06-G01	PLF 10-G03	
	PLF 06-G02	PLF 10-G04	
	PLF 06-G03	PLF 12-G02	
	PLF 08-G01	PLF 12-G03	
	PLF 08-G02	PLF 12-G04	
	PLF 08-G03	PLF 14-G03	
	PLF 08-G04	PLF 14-G04	

POC-G	MODEL [ΦD-T]		
	Tube(Metric)-Thread(G)		
	POC 04-G01	POC 08-G04	POC 16-G03
	POC 04-G02	POC 10-G01	POC 16-G04
	POC 06-G01	POC 10-G02	
	POC 06-G02	POC 10-G03	
	POC 06-G03	POC 10-G04	
	POC 06-G04	POC 12-G02	
	POC 08-G01	POC 12-G03	
	POC 08-G02	POC 12-G04	
	POC 08-G03	POC 14-G04	

PLL-G	MODEL [ΦD-T]		
	Tube(Metric)-Thread(G)		
	PLL 04-G01	PLL 08-G04	PLL 16-G03
	PLL 04-G02	PLL 10-G01	PLL 16-G04
	PLL 06-G01	PLL 10-G02	
	PLL 06-G02	PLL 10-G03	
	PLL 06-G03	PLL 10-G04	
	PLL 06-G04	PLL 12-G02	
	PLL 08-G01	PLL 12-G03	
	PLL 08-G02	PLL 12-G04	
	PLL 08-G03	PLL 14-G04	

PD-G	MODEL [ΦD-T]		
	Tube(Metric)-Thread(G)		
	PD 04-G01	PD 08-G04	PD 14-G04
	PD 04-G02	PD 10-G01	PD 16-G03
	PD 06-G01	PD 10-G02	PD 16-G04
	PD 06-G02	PD 10-G03	
	PD 06-G03	PD 10-G04	
	PD 06-G04	PD 12-G02	
	PD 08-G01	PD 12-G03	
	PD 08-G02	PD 12-G04	
	PD 08-G03	PD 14-G03	

PB-G	MODEL [ΦD-T]		
	Tube(Metric)-Thread(G)		
	PB 04-G01	PB 08-G04	PB 14-G04
	PB 04-G02	PB 10-G01	PB 16-G03
	PB 06-G01	PB 10-G02	PB 16-G04
	PB 06-G02	PB 10-G03	
	PB 06-G03	PB 10-G04	
	PB 06-G04	PB 12-G02	
	PB 08-G01	PB 12-G03	
	PB 08-G02	PB 12-G04	
	PB 08-G03	PB 14-G03	

PMF-G	MODEL [ΦD-T]		
	Tube(Metric)-Thread(G)		
	PMF 04-G01	PMF 08-G04	PMF 14-G04
	PMF 04-G02	PMF 10-G01	PMF 16-G03
	PMF 06-G01	PMF 10-G02	PMF 16-G04
	PMF 06-G02	PMF 10-G03	
	PMF 06-G03	PMF 10-G04	
	PMF 06-G04	PMF 12-G02	
	PMF 08-G01	PMF 12-G03	
	PMF 08-G02	PMF 12-G04	
	PMF 08-G03	PMF 14-G03	

PBF-G	MODEL [ΦD-T]		
	Tube(Metric)		
	PBF 04-G01	PBF 08-G04	PBF 14-G04
	PBF 04-G02	PBF 10-G01	PBF 16-G03
	PBF 06-G01	PBF 10-G02	PBF 16-G04
	PBF 06-G02	PBF 10-G03	
	PBF 06-G03	PBF 10-G04	
	PBF 06-G04	PBF 12-G02	
	PBF 08-G01	PBF 12-G03	
	PBF 08-G02	PBF 12-G04	
	PBF 08-G03	PBF 14-G03	

**Push in fitting  
 Plastic type**

**How to Order**

	MODEL [ΦD-T]	
	Tube(Metric)-Thread(G)	
	PX 04-G01	PX 08-G04
	PX 04-G02	PX 10-G01
	PX 06-G01	PX 10-G02
	PX 06-G02	PX 10-G03
	PX 06-G03	PX 10-G04
	PX 06-G04	PX 12-G02
	PX 08-G01	PX 12-G03
	PX 08-G02	PX 12-G04
	PX 08-G03	

	MODEL [ΦD-T]	
	Tube(Metric)-Thread(G)	
	PHF 04-G01	PHF 12-G04
	PHF 06-G01	
	PHF 06-G02	
	PHF 08-G01	
	PHF 08-G02	
	PHF 08-G03	
	PHF 10-G02	
	PHF 10-G03	
	PHF 12-G03	

	MODEL [ΦD-T]	
	Tube(Metric)-Thread(G)	
	PH 04-G01	PH 12-G04
	PH 06-G01	
	PH 06-G02	
	PH 08-G01	
	PH 08-G02	
	PH 08-G03	
	PH 10-G02	
	PH 10-G03	
	PH 12-G03	

	MODEL [ΦD1-ΦD2-T]	
	Tube(Metric)-Thread(G)	
	PKD 06-04-G01	
	PKD 08-04-G02	
	PKD 08-06-G02	
	PKD 10-08-G03	

	MODEL [ΦD-T]	
	Tube(Metric)-Thread(G)	
	PKB 06-G01	
	PKB 06-G02	
	PKB 06-G03	
	PKB 08-G01	
	PKB 08-G02	
	PKB 08-G03	

	MODEL [ΦD1-ΦD2-T]	
	Tube(Metric)-Thread(G)	
	PLH 04-G01	PLH 08-G04
	PLH 04-G02	PLH 10-G01
	PLH 06-G01	PLH 10-G02
	PLH 06-G02	PLH 10-G03
	PLH 06-G03	PLH 10-G04
	PLH 06-G04	PLH 12-G02
	PLH 08-G01	PLH 12-G03
	PLH 08-G02	PLH 12-G04
	PLH 08-G03	